

Installation Manual

PORTSMOUTH™
SHAKE & SHINGLES

Westlake
Royal Building Products™

Storage and Handling

- If cartons are to be stored outside, do not lay them directly on the ground. Lay them on wood supports (e.g. 2X4)
- Do not store under tarps.
- Do not stack cartons more than 5 high.
- Keep away from heat sources.
- Keep cartons dry until opened

General Information

- This product is not designed for roof applications including mansard roofs. It is designed solely for installation on vertical surfaces.
- Panels must be installed with nails over a code compliant nailable solid substrate such as plywood, oriented strand board, or existing wood siding (minimum $\frac{7}{16}$ " (1.1cm) thick).
- Portsmouth Shake and Shingle siding is a rain screen but not intended to be a water resistive barrier. Therefore, the siding must be installed over a continuous water-resistive barrier with properly integrated flashing.
- For re-siding projects, it may not be necessary to remove existing siding providing all loose boards are re-secured and any rotten boards are replaced. Install furring strips or wall leveling siding underlayment to create a flat surface for the siding. Follow all other details outlined above.

Cutting

- When cutting Portsmouth Shake and Shingle siding panels use a 40-tip carbide blade mounted in the standard (not backwards) position.

Fasteners

When choosing a fastener for Portsmouth Shake and Shingle Siding products, we recommend first checking with local building code officials for possible requirements. In lieu of special code requirements:

- Nails:
 - Nails should be able to penetrate not less than $1\frac{1}{4}$ "(3.2cm) into framing or furring.
 - Nail is to be made of galvanized steel or other corrosion resistant material and should have a head of at least $\frac{5}{16}$ "(.79cm) in diameter and a shank of $\frac{1}{8}$ "(.32cm).
- Screws:
 - Screws must not inhibit the expansion and contraction of the panel(s). Screws should be able to penetrate not less than $1\frac{1}{4}$ "(3.2cm) into framing or furring and should be:
 - Size #8, truss head or pan head.
 - Corrosion-resistant, self-tapping sheet metal type.

SPECIAL NOTES:

- Each panel must be nailed through the round hole in the center of the nail hem to control the direction of normal expansion and contraction. If you are installing a partial panel and the center nail hole has been cut off, drill a nail hole in the center of the nail hem of the cut panel and nail through it.
- Proper panel gap at the seams is critical to allow for expansion and contraction of the panels through temperature changes. Each panel has temperature markings on the right top end indicating the proper panel spacing during installation.
- When fastening these products, always leave a gap of approximately $\frac{1}{32}$ "(0.8mm) between the nail heads and part to allow for expansion and contraction.

Outside Corner Post (Decorative Corners next page)

- Place the corner post in position, allowing a $\frac{1}{4}$ " (6.4mm) gap between the top of the post and the eave or soffit. Position a nail at the top of the upper slot on both sides of the corner post, leaving a gap of approximately $\frac{1}{32}$ " (0.8mm) between the nail heads and the corner posts. The corner post hangs from these nails. The balance of the nailing should be in the center of the slot, 8" to 12" (203mm to 305mm) apart, again leaving a gap of approximately $\frac{1}{32}$ " (0.8mm) between the nail heads and the corner post. This allows for the expansion and contraction to occur at the bottom. The corner post should extend $\frac{3}{4}$ " (19mm) below the bottom of the siding panels. Cut away any exposed nail hems. NOTE: Posts must be straight, square and loosely fastened. Do not twist or flex posts over bowed or twisted wall surfaces.
- If more than one length of post is required, cut the bottom of the upper post and install as shown in figure 1.

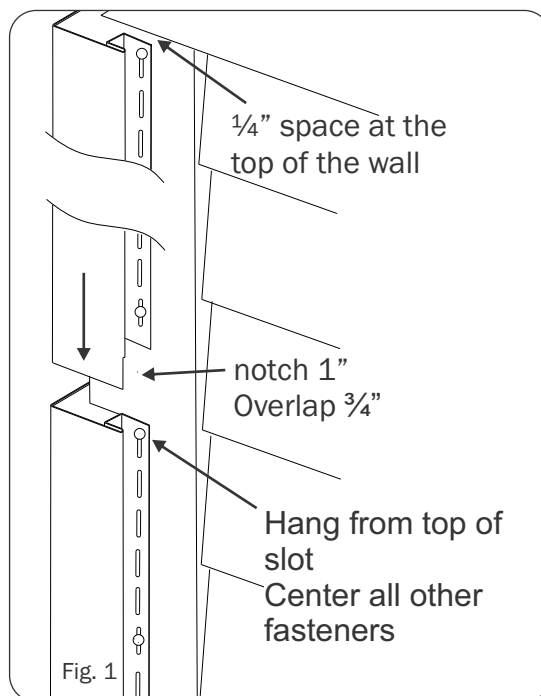

Inside Corner Post

- Inside corner posts are installed in the same manner as the outside posts.

J Channel Trim

- J channel can be used as a siding receiver around areas such as windows, doors and anywhere the panels terminate and the panel expansion gap needs to be concealed.
- Fasten the channel every 8" to 12" (203mm to 305mm) placing the fastener in the center of the nailing slot(s) leaving approx. $\frac{1}{32}$ " (.8mm) gap between the head of the fastener and the vinyl. Leave $\frac{1}{4}$ " where the channel terminates at corners, etc. to allow for expansion.
- If more than one length of channel is required or installing in a gable, cut and lap the two pieces as shown in figure 2.
- When installing J channel around windows and doors, begin with the sill or bottom piece, then the side jambs and finally the header piece.
- Overlap miters over adjoining pieces as shown in figure 3.
- Make sure to retain tabs as shown.
- Secure the channel every 8" to 12" (203mm to 305mm) loosely, leaving approximately $\frac{3}{32}$ " (.8mm) gap between the head of the fastener and the vinyl.
- On vertical pieces, place the first nail in the top of the upper most slot to hold the piece in place and center all other fasteners. All fasteners must be loose.

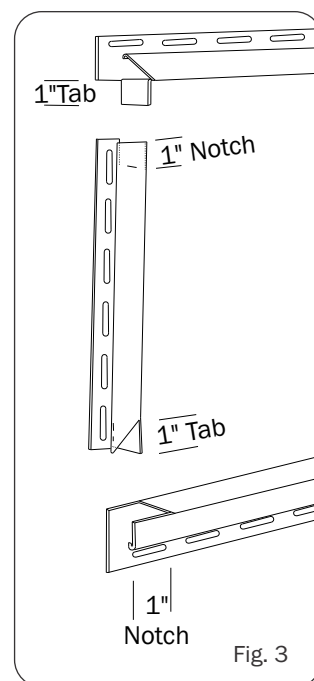
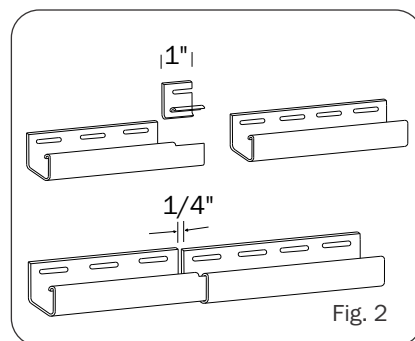

Decorative Corners (available for some profiles)

Note: Decorative corners are installed AFTER the siding panels are applied to adjacent walls. See specific panel instructions for panel details. Depending upon profile, decorative corners may be single or double course.

- Cut the snap hooks as shown in figure 4, from the corner to be installed on the first course.
- Lock the bottom of the corner onto the starter strip, adjust the corner for best fit over the siding panels and fasten at the top of the corner through the nailing slots on both sides (Figure 4).
- Continue to install the corners by pushing the snap hooks located on the bottom of the each corner into the receiving slots near the top of the corner previously installed (Figure 5).
- Adjust for best fit and fasten.
- To secure the last corner, measure as necessary from the top of the corner.
- Shim wall as necessary to maintain the correct angle fit for the panels.
- On each side of the corner near the top, make elongated nailing slots larger than the shaft but smaller than the head of the fastener.
- Snap the bottom of the corner onto the corner below and fasten through the slots at the top (Figure 6).

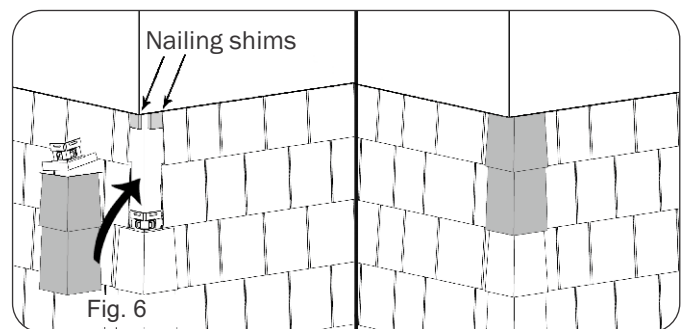
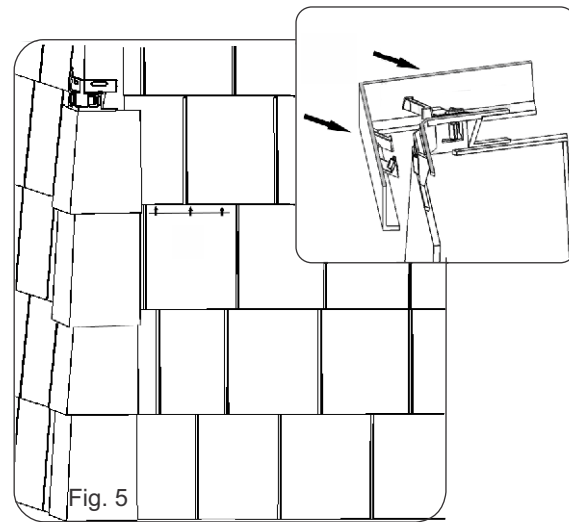
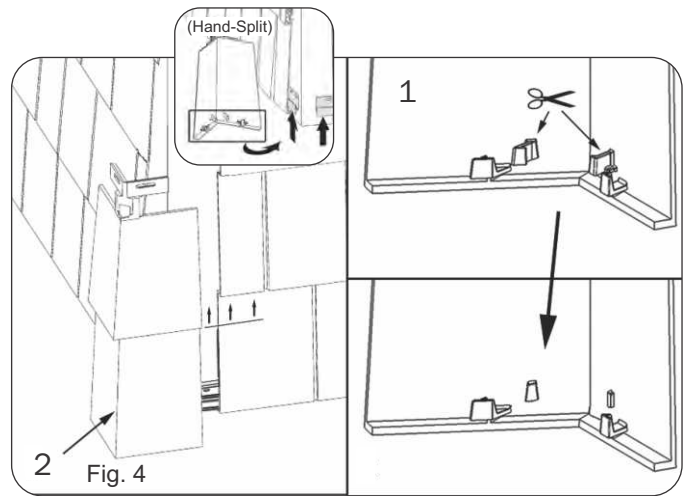

Starter Strip

- Strike a chalk line for the top of the starter strip (Figure 7) keeping in mind that if the installation is directly over a transition band board or above decking, the starter strip will need to be raised another $\frac{3}{4}$ " (19mm) to allow for the panel to be locked into the starter.
- Hold the top of the starter strip along the line and fasten every 8" to 12" (203mm-305mm).
- When using *individual* corners the starter strip should go to corner. For standard vinyl corner posts, leave $\frac{1}{4}$ " (6.35mm) gap inside the corner pocket.
- An alternative method of starting the panels is to use J-Channel in place of starter strip to receive the bottom edge of the panel. Drill $\frac{3}{16}$ " weep holes in J-Channel, a minimum 24" on center..

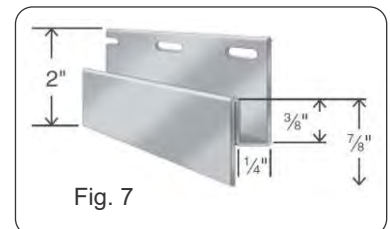

DOUBLE 7" CEDAR SHINGLE INSTALLATION

Note: Before beginning panel installation, review Accessory, etc. installation on previous pages of this guide.

First Course

- Cut the left end of the first panel straight.
- Install the panel by hooking the bottom of the panel onto the starter trip.
- With decorative corners, hold the left end of the panel 2½" (622.3mm) away from the corner of the wall. With standard vinyl corner posts, leave ¼" (6.35mm) gap in the corner pocket for expansion and contraction (Figures 8 and 9).
- Place the first fastener in the round hole in the middle of the nailing hem. This will keep the proper seam spacing though temperature changes (Figure 10).
- Continue to fasten the panel approximately every 10" (254mm) or 5 fasteners per full length panel and one nail in the end slot on the right end of the panel leaving a gap of approximately ⅓₂" (0.8mm) between the nail heads and the panel. If the panel is being installed on furred wall, there must be a furring strip under all the fasteners.
- Install the second and remaining panels by hooking the bottom of the panel(s) onto the starter strip and then sliding to seam with the previous panel.
- Make sure to pay particular attention to space the seam according to the temperature at the time of the installation using the guide lines on the upper right end of the panels (Figure 11).
- Fasten as you did the first panel.
- The last panel at the end of the courses will be cut. A new center nail hole should be drilled (⅛") to help control the expansion and contraction.

Remaining Courses

- Begin the second course by removing 16" (406mm) from the left end of the panel, measuring along the bottom.
- Lock the panel in place making certain that 1) the lock is fully engaged with the panel below and 2) the panel is properly aligned at the left end leaving the necessary spacing depending on the corner system being used.
- Fasten the panel, first in the center hole then at 10" (254mm) spacing leaving a gap of approximately ⅓₂" (0.8mm) between the nail heads and panel.
- Continue installation of the panels and courses alternating the seam placement (Figure 12).

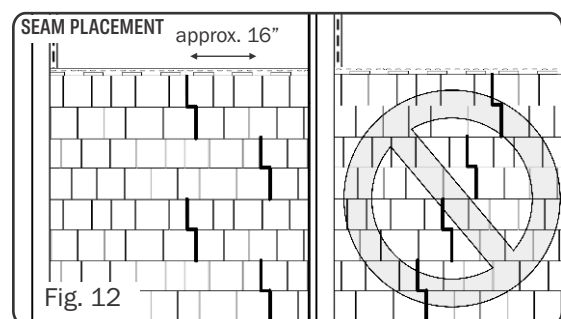
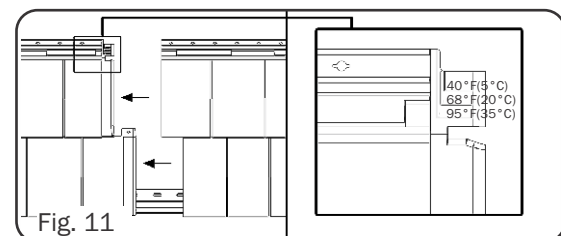
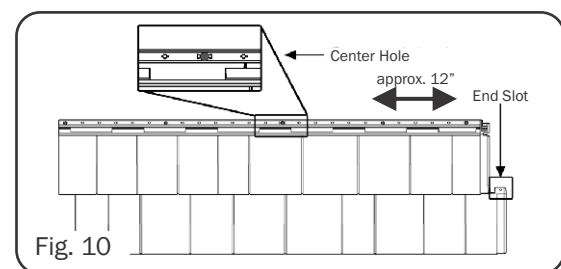
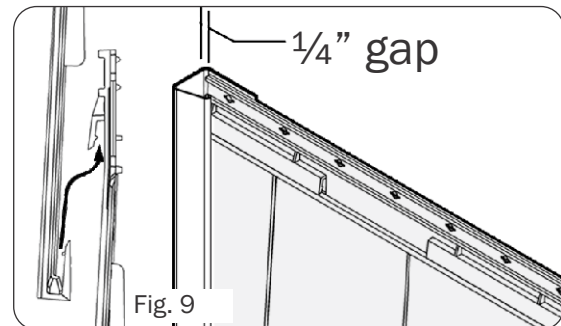
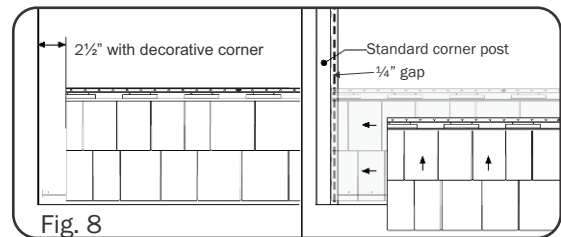

DOUBLE 7" CEDAR SHINGLE INSTALLATION

Under Windows and Top Course

- OPTION 1:** Create nail slots using a nail slot tool, router, etc. to secure the panel(s) while still allowing them to expand and contract. Make certain that the slot is larger than the shaft of the fastener but smaller than the head.
- OPTION 2:** First install shake finish trim. Then measure and cut the panel leaving 1/4" inside the finish trim. Using a snap lock tool, create snap lugs every 6" along the cut edge of the panel. Install the panel making sure the snap lock lugs snap snugly into the finish trim.

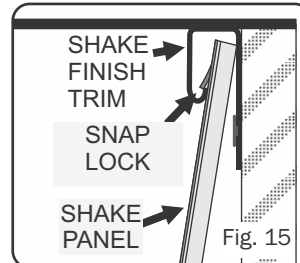
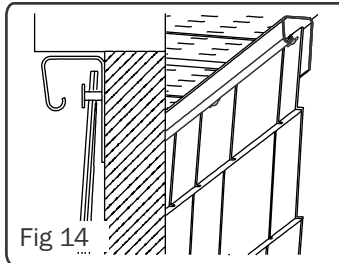
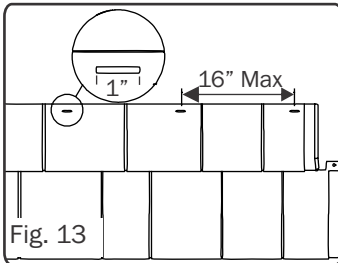

lock lugs snap snugly into the finish trim.



SNAP LOCK TOOL

8' SINGLE 7" CEDAR SHINGLE and HAND-SPLIT SHAKE INSTALLATION

Note: Before beginning panel installation, review Accessory, etc. installation on previous pages of this guide.

First Course

- Install the panel by hooking the bottom of the panel onto the starter trip.
- With decorative corners, hold the left end of the panel 2 1/2" (622.3mm) away from the corner of the wall. With standard vinyl corner posts, leave 1/4" (6.35mm) gap in the corner pocket for expansion and contraction (Figure 17).
- Place the first fastener in the round hole in the middle of the nailing hem leaving a gap of approximately 1/32" (0.8mm) between the nail heads and the panel. This will keep the proper seam spacing though temperature changes (Figure 18).
- Continue to fasten the panel approximately no more than 16" (304mm) apart or 7 fasteners per full length panel. If the panel is being installed on furred wall, there must be a furring strip under all the fasteners.
- Install the second and remaining panels by hooking the bottom of the panel(s) onto the starter strip and then sliding the seam of the previous panel.
- Make sure to pay particular attention to space the seam according to the temperature at the time of the installation using the guide lines on the upper right end of the panels (Figure 19).
- Fasten as you did the first panel leaving a gap of approximately 1/32" (0.8mm) between the nail heads and the panel.
- The last panel at the end of the courses will be cut. A new center nail hole should be drilled (1/8") to help control the expansion and contraction.

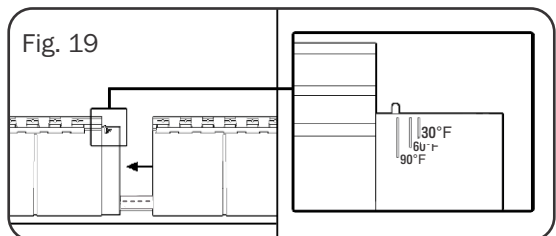
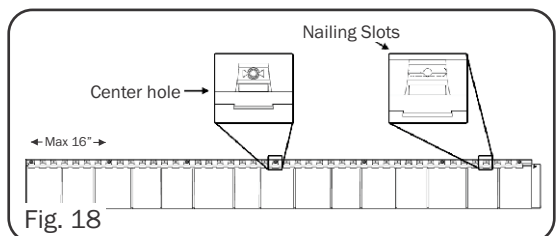
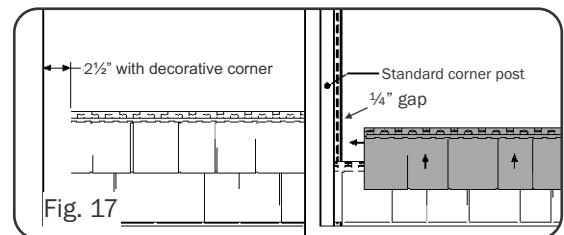

8' SINGLE 7" CEDAR SHINGLE and HAND-SPLIT SHAKE INSTALLATION

Remaining Courses

- Begin the second course by first, cutting either 16"(406mm) or 32"(813mm) from the left end of the panel.
- Lock the panel in place making certain that 1) the lock is fully engaged with the panel below and 2) the panel is properly aligned at the left end leaving the necessary spacing depending upon the corner system being used.
- Fasten the panel, first in the center hole and then at no more than 16"(406mm) spacing (Figure 20).
- Continue installation of the panels and courses.
- Alternate starting panel lengths using full panels, -16"(-406mm) panels and -32"(-813mm) panels (Figure 21).

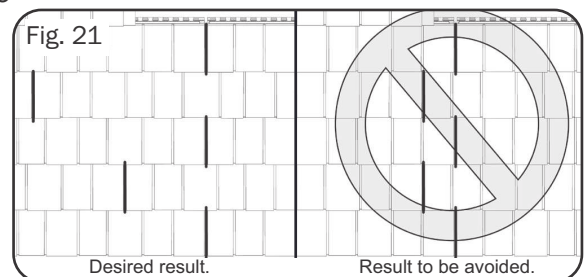
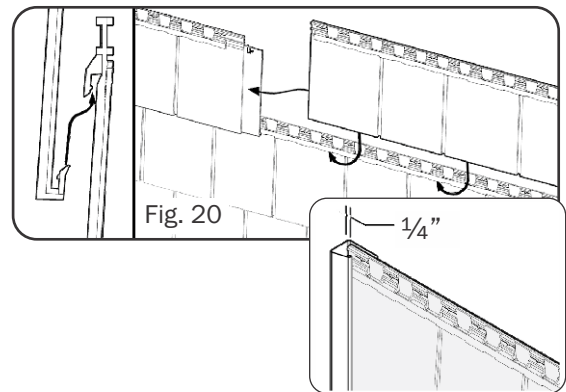

Under Windows and Top Course

- **OPTION 1:** Create nail slots using a nail slot tool, router, etc. to secure the panel(s) while still allowing them to expand and contract. Make certain that the slot is larger than the shaft of the fastener but smaller than the head.
- **OPTION 2:** First install shake finish trim. Then measure and cut the panel leaving 1/4" inside the finish trim. Using a snap lock tool, create snap lugs every 6" along the cut edge of the panel. Install the panel making sure the snap lock lugs snap snugly into the finish trim.

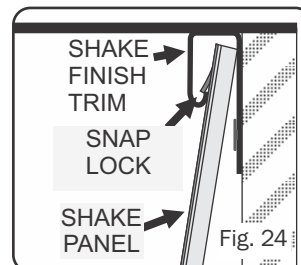
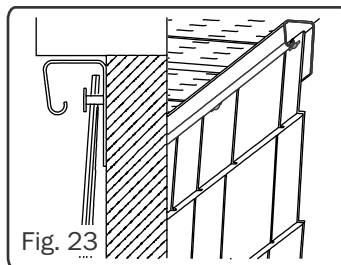
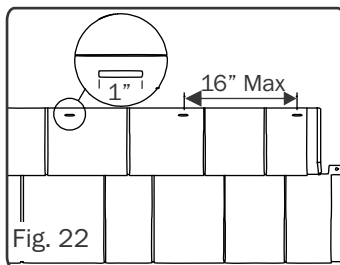

lock lugs snap snugly into the finish trim.



SNAP LOCK TOOL

DOUBLE 5" SHINGLE and 1/2 ROUND INSTALLATION

Note: Before beginning panel installation, review Accessory, etc. installation on previous pages of this guide.

First Course

- Cut the left end of the first panel straight.
- Install the panel by hooking the bottom of the panel onto the starter trip.
- Position the left end of the panel leaving 1/4" (6.35mm) gap in the corner post (Figure 26).^{Fig. 26}
- Place the first fastener in the hole in the middle of the nailing hem. This will keep the proper seam spacing though temperature changes (Figure 27).
- Continue to fasten the panel in the center of the slots approximately every 16" (406mm) leaving a gap of approximately 1/32" (0.8mm) between the nail heads and the panel. If the panel is being installed on furred wall, there must be a furring strip under all the fasteners.
- Install the second and remaining panels by hooking the bottom of the panel(s) onto the starter strip and then sliding the seam of the previous panel.
- Make sure to pay particular attention to space the seam according to the temperature at the time of the installation using the guide lines on the upper right end of the panels (see table below).
- Fasten as you did the first panel.

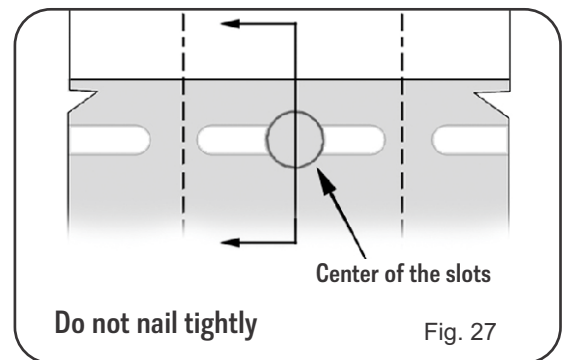
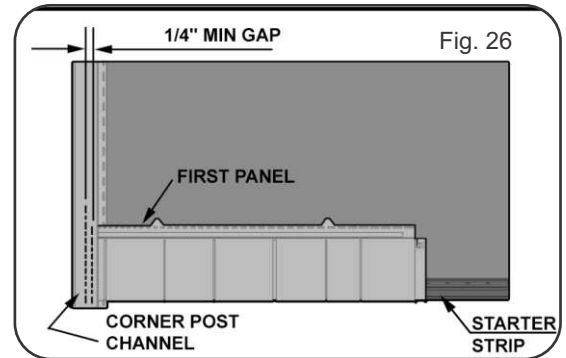

Air Temperature Range in °F	Position on the Temperature Marking
91° and above	On the 100° line
90° - 76°	Between 65° and 100° lines
75° -56°	On the 65° line
55° -41°	Between the 30° and 65° lines
40° and below	On the 30° line

TEMPERATURE MARKINGS

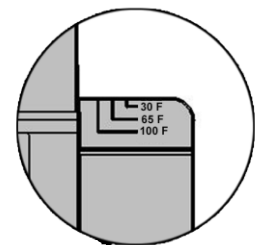

Remaining Courses

- Begin each subsequent course with random length panels to prevent a repetitive joint or grain pattern.
- Lock the panels in place making certain that 1) the lock is fully engaged with the panel below and 2) the panel is properly aligned at the left end leaving the 1/4" gap at both ends of the course (Figure 28).
- Fasten the panels, first in the center hole and then at no more than 16" (406mm) spacing.
- Where the seams of upper course panels meet, it is advised that a nail be placed in the lower course directly below the seam.
- Make sure a minimum of 6" (152mm) of the continuous lock is exposed for the next course to lock onto (Figure 29).

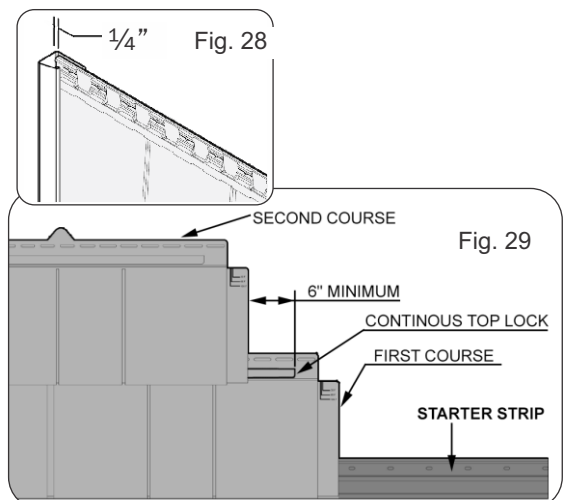

DOUBLE 5" SHINGLE and 1/2 ROUND INSTALLATION

1/2 Round Note:

- Each course of 1/2 rounds should have the center of the scallop aligned with the groove between the scallops of the course below it (Figure 30).
- Panels must overhang more than 8" (203mm) than the course below it.

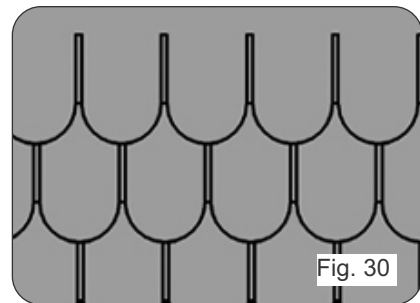

Fig. 30

Under Windows and Top Course

- In areas where the nailing hem must be removed, nailing slots must be created to secure the panel(s) while still allowing them to expand and contract. Make certain that the slot is larger than the shaft of the fastener but smaller than the head.
 - First measure from inside of the trim channel on the wall to the bottom edge of the continuous top lock minus 1/4" (.64cm) (Figure 31).
 - Measuring from the location shown in the diagram and transfer the measurement to the panel(s) (Figure 32).
 - Remove the upper section of the panel and discard.
 - Install the panel(s) and fasten as shown below.
- Create nail slots using a nail slot tool, router, etc. to secure the panel(s) while still allowing them to expand and contract. Make certain that the slot is larger than the shaft of the fastener but smaller than the head (Figures 33, 34).

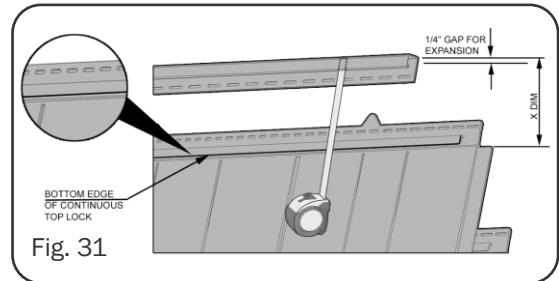

Fig. 31

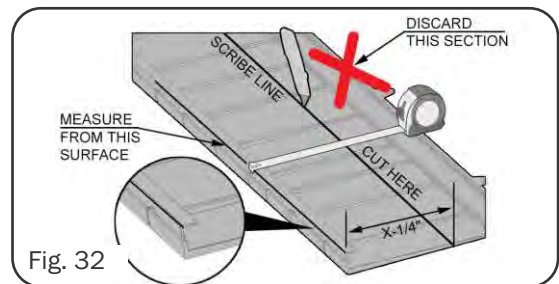

Fig. 32

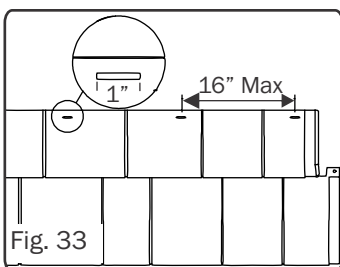

Fig. 33

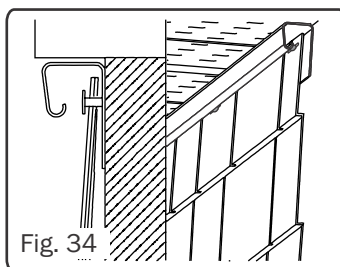
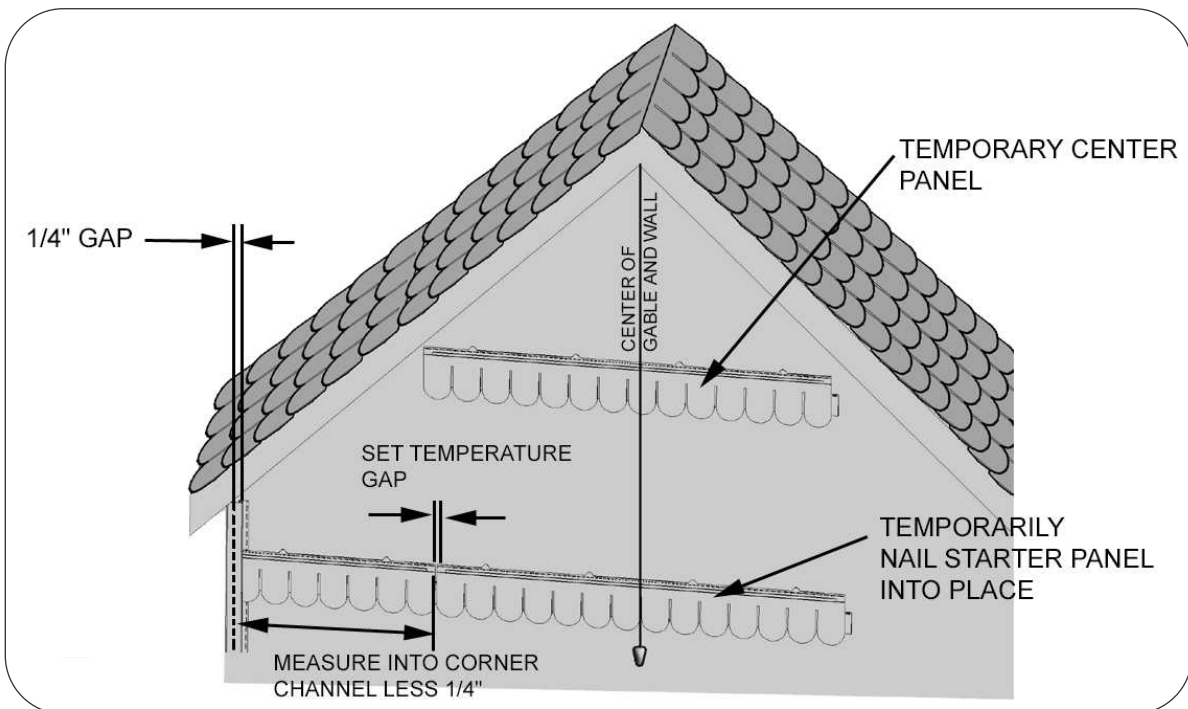
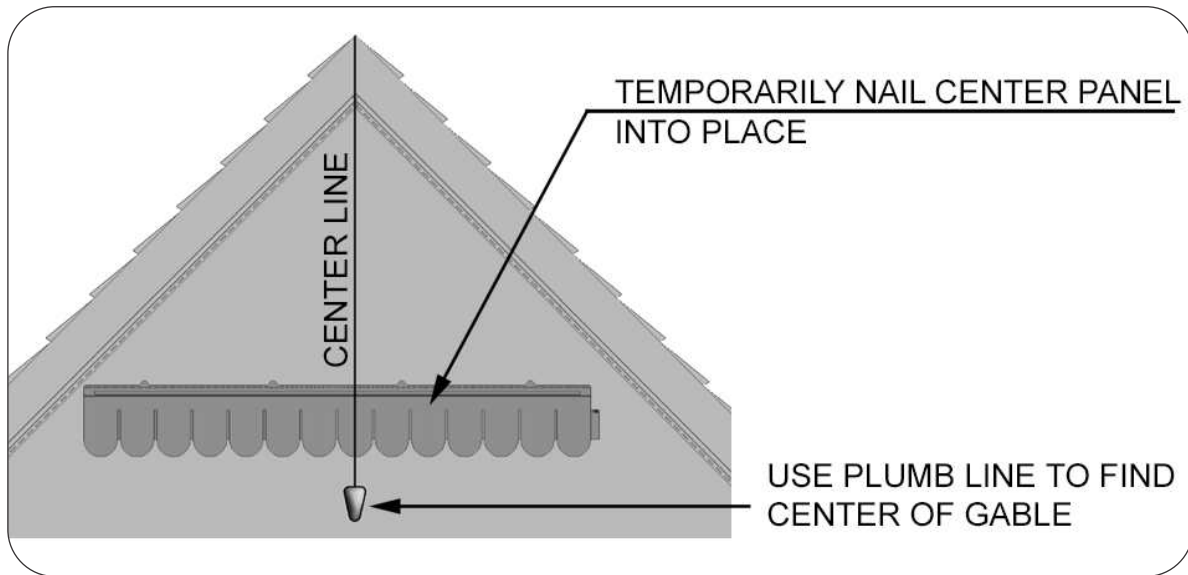

Fig. 34

1/2 ROUND BALANCED INSTALLATION IN GABLES

- Locate the center of the wall prior to beginning installing the 1/2 round panels.
- Temporarily install the center panel.
- Temporarily install to the left most full panel keeping in mind the seam spacing according to the temperature.
- Measure and cut the starting panel.
- Once the starting panel is established, remove the temporary panels and begin installing the first course.
- Leave 1/4" in all receiving channels.





Westlake
Royal Building Products™